

INSTALLATION CERTIFICATE

The undersigned qualified installer attests to have personally fitted the alarm system on the here described vehicle following the manufacturer instructions.

By :

Sold on :

Type of device : 932IT

Vehicle :



932IT

INSTALLATION AND USER GUIDE



GEMINI Technologies S.r.l.
Via Luigi Galvani 12 - 21020 Bodio Lomnago (VA) - Italy
Tel. +39 0332 943211 - Fax +39 0332 948080
www.gemini-alarm.com
ISO 9001 Certified Company

CE
Made in Italy

Rev.02 - 06/17

1.0 - INTRODUCTORY NOTE

USER GUIDE

2.0 - OPERATING INSTRUCTIONS

- 2.1 - Complete system arming
- 2.2 - System arming with sensor exclusion
- 2.3 - Passive arming
- 2.4 - Arming delay
- 2.5 - System armed
- 2.6 - Alarm, inhibit time between alarms and alarm cycles
- 2.7 - System disarming
- 2.8 - Emergency override via touch key
- 2.9 - Engine immobilizer unlock
- 2.10 - Alarm memory

3.0 - OPTIONAL DEVICES AND BATTERY REPLACEMENT

- 3.1 - TWO-BUTTON REMOTE CONTROL - 7208E
- 3.2 - FOUR-BUTTON REMOTE CONTROL - 848/ALG
- 3.3 - RFID TRANSPONDER - 908

INSTALLER MANUAL

4.0 - PINOUT TABLES

- 4.1 - 20-pin connector
- 4.2 - 8-pin connector

5.0 - WIRING DIAGRAM

6.0 - CONNECTIONS TO ARM/DISARM THE SYSTEM

- 6.1 - Connections and operation via CAN BUS line
- 6.2 - Connections to locking motors
- 6.3 - Connections to turn indicators
- 6.4 - Combination connection

7.0 - VEHICLE CODE PROGRAMMING

8.0 - SYSTEM PROGRAMMING

- 8.1 - Optical signals
- 8.2 - Acoustic signals
- 8.3 - Passive arming
- 8.4 - Siren triggered when immobilizer is ON with system disarmed
- 8.5 - Door switch polarity selection
- 8.6 - Hazard warning lights or negative output during an alarm

9.0 - SYSTEM PROGRAMMING EXAMPLE

10.0 - ADDING NEW DEVICES

11.0 - DELETING PROGRAMMED DEVICES

12.0 - ULTRASONIC VOLUMETRIC PROTECTION

- 12.1 - Connections and positioning
- 12.2 - Sensor adjustment

13.0 - SYSTEM RESET

14.0 - TECHNICAL SPECIFICATIONS

15.0 - WASTE ELECTRICAL AND ELECTRONIC EQUIPMENT (WEEE) DIRECTIVE

1.0 - INTRODUCTORY NOTE

Dear Customer, thank you for choosing a Gemini alarm system.

This product, supplied with 1 touch key to emergency override the system and exclude the sensors, can also be managed by the following Gemini optional devices:

- an RFID transponder (908)
- a 2-button remote control (7208E)
- a 4-button remote control 848/ALG

Please read the present manual carefully to familiarize yourself fully with the operation of your alarm system and pay special attention to the following signs:



For the user.
This sign highlights useful information.



For the installer.
This sign indicates that the system will operate according to the connections and the selected configuration or it simply provides helpful information on installing the alarm system.

USER GUIDE

2.0 - OPERATING INSTRUCTIONS

2.1 - SYSTEM TOTAL ARMING

Press the vehicle original remote control lock button or button “1” on a Gemini remote control. If the optical/acoustic signals have been enabled, arming will be confirmed by 1 flash of the turn indicators and 1 Beep.

The system has a 30 sec. arming delay signaled by the LED turned ON steady.

When the system is fully armed, after the arming delay, the LED will blink according to the associated devices (ex. if the alarm system works with 1 touch key and 1 remote control, the flashing sequence, while the alarm is armed, will be the following: 2 quick flashes in a row followed by a pause.).

2.2 - SYSTEM ARMING WITH SENSOR EXCLUSION

The system can be armed without enabling the internal volumetric protection (ultrasonic sensors) and optional wireless PIR sensors.

To arm the system and exclude the sensors proceed as follows:

- Touch the key to its receptacle; the LED will give off a quick flash.
- Close all doors and press the original remote control lock button or button “1” on remote control 7208E.

NB: With remote control 848/ALG, simply press button “3” without touching the override key to its receptacle.

- Arming will be confirmed by optical/acoustic signals (if enabled).



Sensor exclusion is bound to each single arming cycle.

2.3 - PASSIVE ARMING

If programmed for passive arming, the system will automatically arm approx. 60 sec. after ignition is switched OFF and the last door is opened and closed.

System arming will be confirmed by optical/acoustic signals (if enabled).



When the system arms automatically, internal sensors are not enabled. Opening a door 60 sec. before the system is armed will cause the procedure to interrupt; it will resume once the door is closed.

2.4 - ARMING DELAY

There is a 30 sec. delay from the time the system is armed to allow you to leave the vehicle without triggering an alarm: it will be signaled by the LED turned ON steady.

2.5 - SYSTEM ARMED

After the delay time the system is fully armed and ready to detect any alarm event. The LED will flash according to the associated devices (ex. if the alarm system works with 1 touch key and 1 remote control, the flashing sequence, while the alarm is armed, will be the following: 2 quick flashes in a row followed by a pause).

2.6 - ALARM, INHIBIT TIME BETWEEN ALARMS AND ALARM CYCLES

Alarm events are signaled by optical/acoustic signals. Once the alarm ceases, there is a 5 sec. time-interval before another alarm can be triggered.

Each alarm event can generate up to 10 cycles for each input and for each arming cycle. One alarm cycle lasts for 30 sec.

2.7 - SYSTEM DISARMING

Press the unlock button on the vehicle original remote control. System disarming will be confirmed by 2 siren chirps and 2 flashes of the turn indicators (if enabled).

ATTENTION: When disarming via the original remote control, if you do not have a transponder, the LED will flash quickly to warn you that the engine immobilizer is still enabled and the vehicle cannot be started. You must touch the override key to its receptacle.

Disarming via an optional Gemini remote control:

Pressing button "2" on a Gemini remote control will simultaneously disarm the alarm and disable the engine immobilizer.

If an alarm event has occurred while you were away from your vehicle, it will be signaled, when you disarm the system, by 5 siren chirps and 5 flashes of the turn indicators.

Alarm causes and relative LED signals are listed in par. 2.9 "ALARM MEMORY".

2.8 - EMERGENCY OVERRIDE VIA TOUCH KEY

The touch key is used to override the system as an emergency backup and to fully disarm the system. By touching the key to its receptacle, the system disarms and switches OFF.

It will not rearm by pressing the remote control lock button on the original remote nor the one on the Gemini remote.



To restore normal operation, touch the key to its receptacle. A quick chirp and a flash of the status LED will acknowledge that the system has been restored to normal operation.

2.9 - ENGINE IMMOBILIZER UNLOCK



This function is only enabled if the system is paired with a GEMINI 908 TAG (optional radio transponder).

When the TAG is paired, the engine immobilizer (if connected) is automatically enabled when the doors are locked via the vehicle original remote control or via a Gemini remote control but will not automatically disable when the doors are unlocked unless it receives an authorized code transmitted by one of the following Gemini devices:

- the supplied emergency override touch key;
- the Gemini transponder which allows "Hands Free" interaction with the vehicle;
- a Gemini remote control (7208 or 848 optional) which can arm/disarm the alarm system including the immobilizer and, for vehicles with negative door trigger, lock/unlock the doors (if connected).

2.10 - ALARM MEMORY

The LED memory allows to identify the last alarm event signaled by 5 siren chirps and 5 turn indicator flashes when the system is disarmed.

Turn ignition key "ON". The status LED will flash according to the last alarm detected prior to disarming (see table below).

The flash sequence is repeated 3 times; to interrupt simply turn ignition key "OFF".

The table below lists the various alarm causes and relative number of LED flashes.

LED FLASHES	ALARM CAUSES	ALARM CYCLES
* * * ● * * *	Ignition attempt (+15/54)	10
* * * * ● * * * *	Door opening	10
* * * * * ● * * * * *	Bonnet opening	10
* * * * * * ● * * * * * *	Boot opening	10
* * * * * * * ● * * * * * * *	Volumetric or external sensor	10
* * * * * * * * ● * * * * * * * *	Wireless magnetic contacts or opening detectors	10
* * * * * * * * * ● * * * * * * * * *	Wireless (PIR) sensors	10
* * * * * * * * * * ● * * * * * * * * * *	Wire tampering	10
● LED OFF (2 seconds) * LED ON (1 second)		

3.0 - OPTIONAL DEVICES AND BATTERY REPLACEMENT

Remote controls have a low charge battery indicator that gives early warning to avoid malfunctioning. When the batteries are fully charged the LED shows a steady light at the press of a button while, if the batteries are low, the LED blinks.

3.1 - TWO-BUTTON REMOTE CONTROL - 7208E

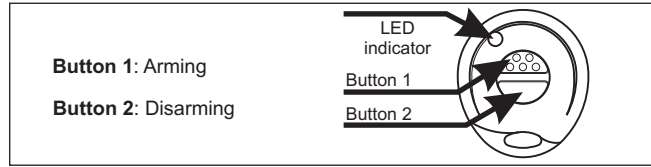

REPLACING THE BATTERIES:

- Separate the remote shells taking care not to damage the internal circuit.
- Remove the discharged batteries.
- Insert the new batteries. Pay attention not to invert the battery polarity.
- Close the remote shells.
- Make sure the remote works properly.

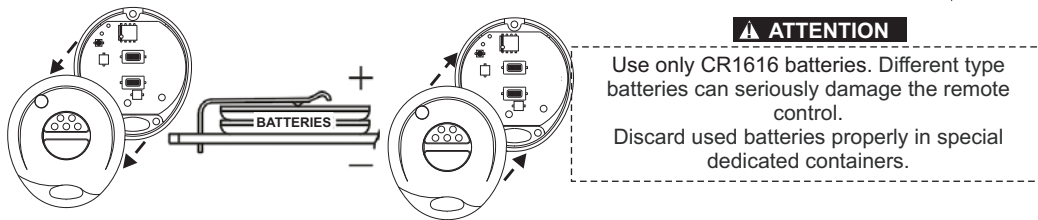

3.2 - FOUR-BUTTON REMOTE CONTROL - 848/ALG

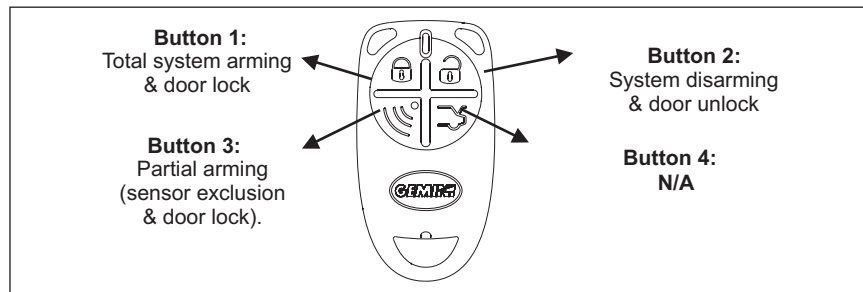

REPLACING THE BATTERY:

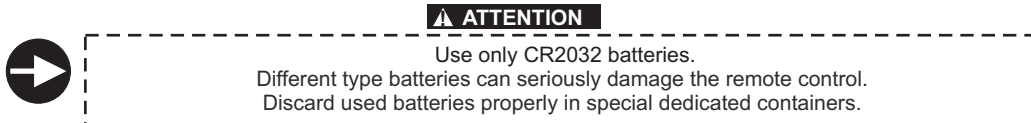
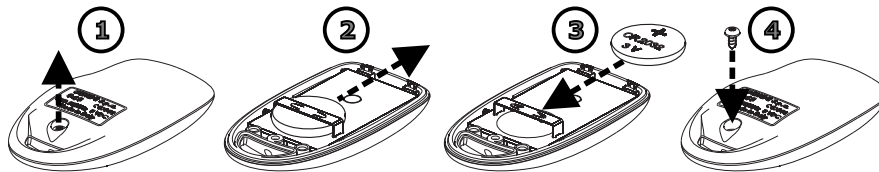

3.3 - RFID TRANSPONDER - 908

to disable the engine immobilizer. To activate the transponder simply press the button and keep it pressed for at least 4 sec. The LED turns ON steady when the transponder is activated. Release the button. The LED will flash everytime data is transmitted.

If no movement is detected within 10 min. the transponder automatically goes into standby mode to save battery life; to wake it up for another 10 min., move it or press the button. Press the button again to send a radio signal to the alarm system.

To switch OFF the transponder, press and hold the button for approx. 10 sec., the LED will be ON steady. It will flash twice just before the transponder switches OFF.

REPLACING THE BATTERY:

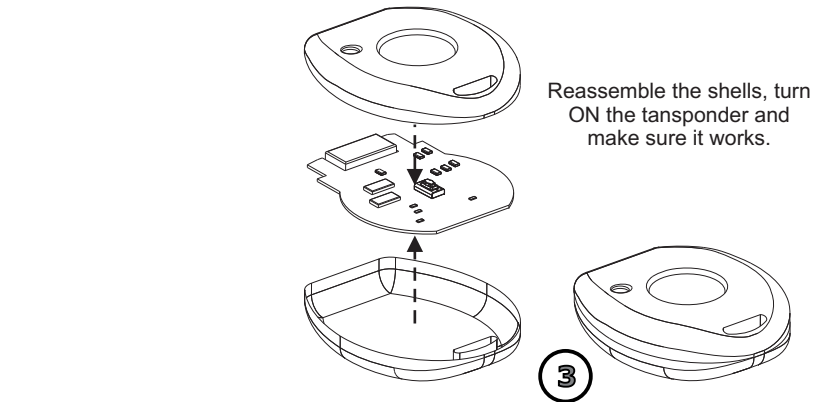
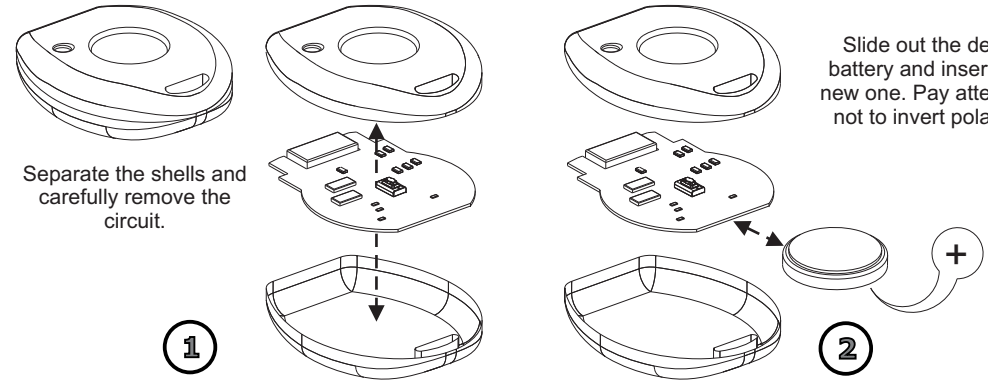

4.0 - PINOUT TABLES

4.1 - 20-PIN CONNECTOR

POSITION	WIRE FUNCTION	WIRE COLOR
- 1 -	-----	-----
- 2 -	System arming confirmation signal	YELLOW-BLUE
- 3 -	System disarming confirmation signal	GREEN-BLUE
- 4 -	-----	-----
- 5 -	Door switches - Positive/negative input	GREEN-BROWN
- 6 -	Touch key receptacle input	GREEN
- 7 -	Touch key receptacle ground	BROWN
- 8 -	LED negative output	BLACK
- 9 -	LED positive output	RED
- 10 -	Ignition	BLACK marked "G"
- 11 -	CAN BUS (CAN-H) signal	LIGHT BLUE-GREY
- 12 -	CAN BUS (CAN-L) signal	LIGHT BLUE
- 13 -	Positive output - System armed (+A)	PINK
- 14 -	External sensors negative input	GREEN-BLACK
- 15 -	Bonnet switch negative input	GREEN
- 16 -	Hazard lights or negative output during alarm (siren, pager, tracker)	BLUE
- 17 -	Lock command (1,5 sec.* negative pulse when pressing remote control button "1" or "3")	WHITE-BLACK
- 18 -	Unlock command (1 sec. negative pulse when pressing remote control button "2")	YELLOW-BLACK
- 19 -	-----	-----
- 20 -	Input for learning and arming/disarming via turn indicator flashes	WHITE-ORANGE

* If this function is enabled, the lock/unlock pulse will be 0,5 sec. instead of 1,5 sec.

4.2 - 8-PIN CONNECTOR

POSITION	WIRE FUNCTION	WIRE COLOR
- 1 -	Ground	BLACK marked "M"
- 2 -	Siren output	-----
- 3 -	Positive supply	BLACK marked "R"
- 4 -	Turn indicators positive output	ORANGE
- 5 -	Engine immobilizer	BLACK marked "H"
- 6 -	Siren output	-----
- 7 -	Engine immobilizer	BLACK marked "H"
- 8 -	Turn indicators positive output	ORANGE

For more complete information regarding connections, refer to the supported vehicle models installation instructions at www.gemini-alarm.com (private area).

5.0 - WIRING DIAGRAM

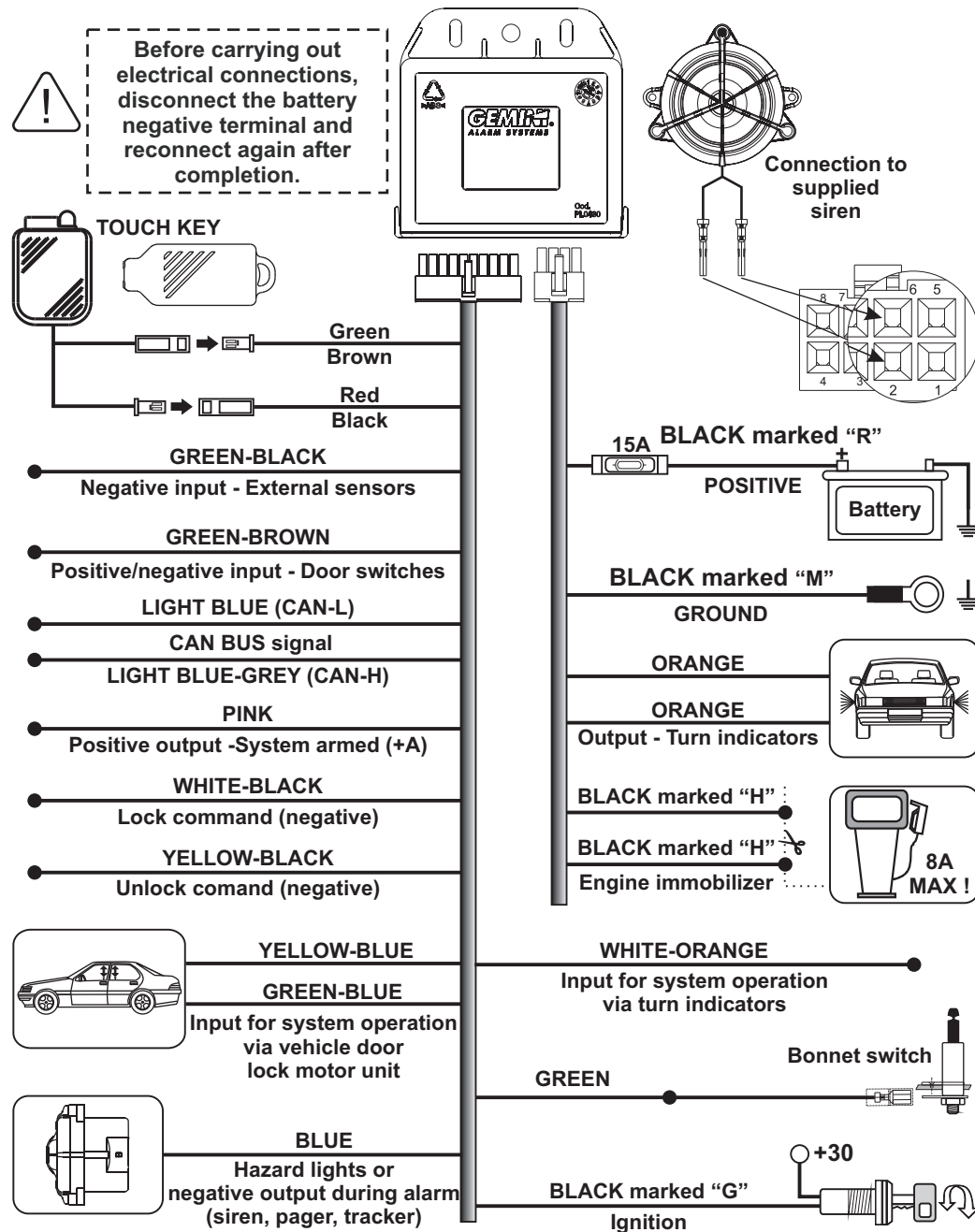

6.0 - CONNECTIONS TO ARM/DISARM THE SYSTEM

The 932IT alarm system can operate in various modes according to the vehicle on which it is installed and the available connections.

The alarm system can be managed via the vehicle CAN BUS line and operate in combination with the CAN signals, with the turn indicators flashes and/or the door lock motor unit. The system automatically manages the different arming/disarming signals.

Select one of the arming modes and connections indicated hereunder (refer to the vehicle specific installation instructions available in the private area of our website).

- Arming via CAN BUS.
- Arming via door lock motor unit.
- Arming via turn indicators flashes.
- Arming via turn indicators flashes and locking motors.
- Arming via turn indicators flashes, locking motors and CAN BUS line.

6.1 - CONNECTIONS AND OPERATION VIA CAN BUS LINE

System arming/disarming and alarms are managed via CAN therefore only connect the alarm system CAN wires to the vehicle CAN lines (see available installation guidelines in the private area of our website: www.gemini-alarm.com).

6.2 - CONNECTIONS TO LOCKING MOTORS

System arming/disarming connections must be made to the vehicle door lock motor unit (invert polarity).

6.3 - CONNECTIONS TO TURN INDICATORS

- ! If the turn indicators lock/unlock flashes are identical, also connect the door lock motors.
- ! If the turn indicators flash when unlocking with the car mechanical key, do not make this connection.

To arm/disarm the system, connect the WHITE-ORANGE wire to one of the turn indicator wires.

6.4 - COMBINATION CONNECTION

This type of connection allows the system to operate via the CAN line in combination with the turn indicators or the door lock motor unit or both.

The system automatically manages the different lock/unlock signals according to the selected configuration and connections.

7.0 - VEHICLE CODE PROGRAMMING

The system must be configured based on the vehicle model on which it is installed. Here below is an example illustrating the configuration procedure. In this case the code to be entered is 1-0-3 which hypothetically corresponds to a "FIAT XXXXX".



A separate leaflet, included in the alarm packaging, lists the available vehicles (codes are updated at packaging time).
Up-to-date information on supported vehicle models can be found in the private area of our website: www.gemini-alarm.com.



The system has an indicator LED that signals any wrong vehicle code inserted. The code must range between 100 and 235 otherwise the LED on the unit blinks repeatedly and the procedure is interrupted. The previously inserted code remains stored. The procedure is also invalidated if the LED blinks more than 10 times. In this case there are no optical warnings, the procedure is simply interrupted. In either case, repeat the entire procedure.

Connect the wiring harness connectors to the corresponding alarm connectors.
Press and hold the button shown below until the LED lights up.



Release the button, the LED will go out.

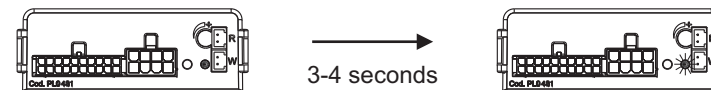

After 3 to 4 seconds, the LED will start flashing.
Press the button at the first flash which corresponds to number "1".

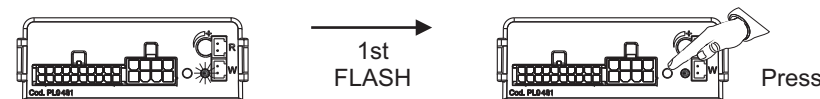

After another 4 seconds, the LED will start flashing again.
Press the button at the 10th flash which corresponds to "0".

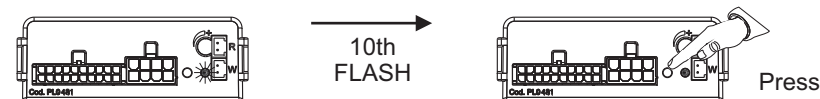

After 4 more seconds, the LED will flash for the third and last time.
Press the button at the 3rd flash which corresponds to number "3".

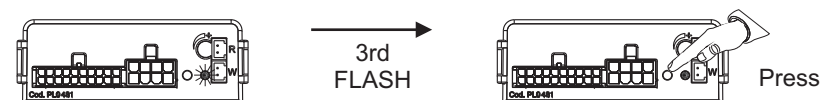

When the last digit is entered, the alarm system “repeats” the entered code.

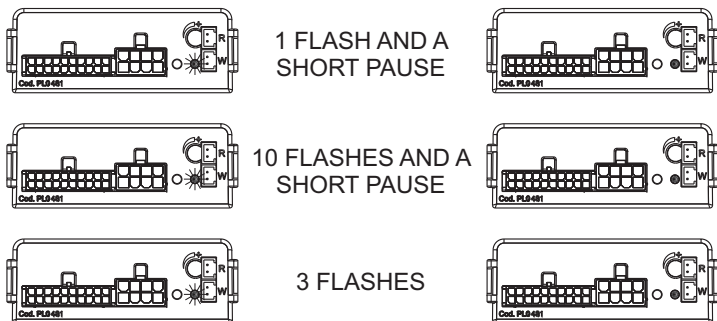

Press the vehicle remote control lock/unlock buttons to make sure the alarm system works properly. Eventually disconnect the 8-pin connector and reconnect it after a few seconds.

8.0 - SYSTEM PROGRAMMING

The table below applies to the system programmed in “standard configuration”. Every time you enter the programming procedure, the alarm resets to the default settings.

FUNCTION	STATUS	LED FLASHES
“Exclusion” of arming/disarming optical signals	Enabled	*
“Exclusion” of arming/disarming acoustic signals	Enabled	**
System passive arming	Disabled	***
Siren triggered when immobilizer is ON (system disarmed)	Disabled	****
Door input - positive	Disabled	*****
Optical pulse signals (Hazard)	Enabled	*****
For Gemini only: Turn ignition key	-----	*****

A lack of power during electrical system maintenance, will not affect the programming. The procedure must always be carried out entirely. Every key rotation disables the selected function and moves to the next option until the programming procedure is completed.

8.1 - OPTICAL SIGNALS

This function activates the optical signals (turn indicator flashes) that confirm system arming/disarming (signals are factory disabled).

 If the vehicle already has optical lock/unlock signals, the turn indicators alarm flashes should be disabled.

8.2 - ACOUSTIC SIGNALS

This function activates the acoustic signals (siren chirp) that confirm system arming/disarming (signals are factory disabled).

8.3 - PASSIVE ARMING

This function arms the system 60 sec. after ignition is switched OFF and the last door is opened and closed. If a door is opened during this lapse of time, the procedure is interrupted; it resumes when the door is closed.

8.4 - SIREN TRIGGERED WHEN IMMOBILIZER IS ON WITH SYSTEM DISARMED

When the system is disarmed, this function triggers the siren as a warning that the immobilizer is ON and the engine cannot be started. Therefore if ignition key is cycled ON when the immobilizer is armed the siren will sound until ignition is switched OFF.

8.5 - DOOR SWITCH POLARITY SELECTION

This function modifies the alarm input signal (positive or negative) based on the signal generated by the door switch.

8.6 - HAZARD WARNING LIGHTS or NEGATIVE OUTPUT DURING ALARM

This function activates the optical signals based on the connections made.
NB: Only for vehicles where hook-up is to the Hazard warning lights.

 Optical signals activated by connection to the Hazard switch ONLY turn ON during an alarm condition.
The alarm BLUE wire MUST be connected to the Hazard switch.
In this case, do not connect the alarm ORANGE wires to the turn indicator wires.

If this function is disabled, the BLUE wire will carry a negative signal during an alarm cycle.

9.0 - SYSTEM PROGRAMMING EXAMPLE

Here below is an example that illustrates the various steps to modify the programmable functions. As mentioned before, every key cycle disables the functions, while the touch key enables them. Two different tones will sound depending on the action taken and the LED will flash according to the selected function (see par. 8.0).

With the system disarmed, turn ignition key “ON” and, while the LED is ON, touch the key to its receptacle.

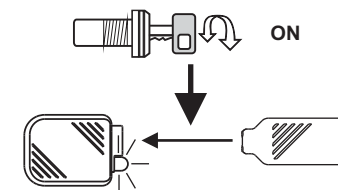

Two acoustic signals (a Beep and a Bop) and two flashes of the turn indicators will acknowledge that the system has entered in programming mode.



Turn ignition key "OFF" and then back "ON" to disable the function.
A Bop confirms the operation.
The LED flashes according to the selected function (from 1 to 7).

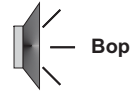

OR



Touch the key once to its receptacle to enable the function.
A Beep confirms the operation.
The LED flashes according to the selected function (from 1 to 7).



In both cases, the system moves on to the next function.
Repeat the above steps to enable or disable other functions.

When the last function is programmed (either with the touch key or the ignition key), in addition to the confirmation tone, 2 Bops and 1 Beep will sound and the turn indicators will flash twice.

These last 2 signals confirm the end of the programming procedure.

10.0 - LEARNING NEW DEVICES



To carry out the operation successfully, make sure the required connections (bonnet switch and ignition) are complete.
If there is no bonnet switch, ground the GREEN wire (20-pin connector, pos. 15).



Storing memory is for 55 devices.
If an extra device is added, it automatically deletes the first device stored in memory.

To activate the code-learning mode proceed as follows:

• With the system disarmed, open the vehicle bonnet and keep it opened or ground the GREEN wire.

ATTENTION: During the learning procedure, make sure there are no active transponders or remote controls in use nearby otherwise they will also be paired.



The following "ON-OFF" cycles must be carried out within 4 seconds otherwise the procedure is invalidated.

- Cycle the ignition key 4 times: "ON-OFF" - "ON-OFF" - "ON-OFF" - "ON".
- At the 4th cycle leave ignition "ON".
- To confirm it has entered in learn mode, 2 acoustic signals will sound (a Beep and a Bop), the turn indicators will flash once and the status LED will turn ON.



Do not close the bonnet otherwise all previously programmed devices will be erased as described in the next paragraph.

- The system is ready to receive the device codes.
- Depending on which device is to be stored in memory, either press one of the buttons on the remote control, touch the key to its receptacle, have the transponder transmit, make the magnetic contact transmit (bring contact and magnet together and then move apart), press the button on the opening detector or make the infrared sensor transmit (see sensor instructions).
- If learning is successful, a short Beep will sound and the LED will go out for 1 sec.
- Repeat this same procedure to learn other devices.
- Turn ignition key "OFF".
- A Bop will sound, the turn indicators will flash once and the status LED will go out to confirm the end of the procedure.
- Close the bonnet or remove the GREEN wire from ground (bonnet switch).

11.0 - DELETING PROGRAMMED DEVICES



To carry out the operation successfully, make sure the required connections (bonnet switch and ignition) are complete.
If there is no bonnet switch, ground the GREEN wire (20-pin connector, pos. 15).

All devices previously programmed in the system memory can be deleted. To clear the memory proceed as follows:

- With the system disarmed, open the vehicle bonnet and keep it opened or ground the GREEN wire.



The following "ON-OFF" cycles must be carried out within 4 seconds otherwise the procedure is invalidated.

- Cycle the ignition key 4 times: "ON-OFF" - "ON-OFF" - "ON-OFF" - "ON".
- At the 4th cycle leave ignition "ON".
- To confirm it has entered in clear mode, 2 acoustic signals will sound (a Beep and a Bop), the turn indicators will flash once and the status LED will go out.
- Close the bonnet or remove the GREEN wire from ground (bonnet switch).
- To clear the memory, leave the bonnet closed for at least 8 sec.



If the bonnet is opened before 8 sec., the devices will not be deleted.

- The LED will switch OFF when the devices have been deleted.
- Turn ignition key "OFF".
- A long low-pitched sound confirms the end of the clearing procedure.

12.0 - ULTRASONIC VOLUMETRIC PROTECTION

12.1 - CONNECTIONS AND POSITIONING

- Insert the WHITE connector in the “W” socket.
- Insert the RED connector in the “R” socket.
- Install the ultrasonic sensors on the top part of the windshield internal pillars, away from the air vents and point them towards the center of the rear window.

12.2 - SENSOR ADJUSTMENT

To check the sensitivity level proceed as follows:

- With the alarm system disarmed, roll down the front window approx. 20 cm.
- Set the trimmer to an intermediate position (medium sensitivity).
- Close all doors, bonnet and boot and arm the system.
- During the arming delay introduce an object in the cabin through the window and move it around; the status LED will turn OFF to signal a presence.
- If the sensitivity level is too high or too low, readjust the trimmer and repeat the above procedure.

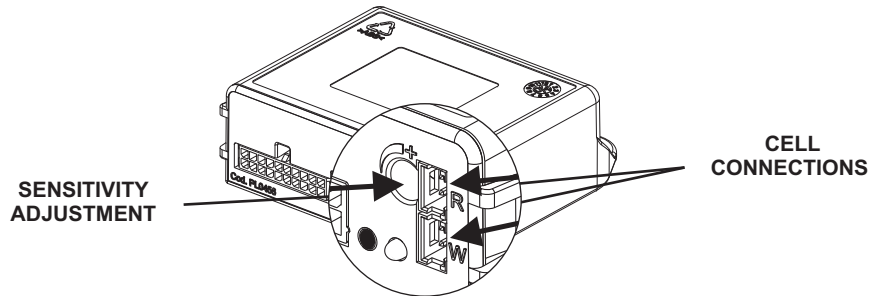

13.0 - SYSTEM RESET



This procedure will restore factory settings therefore any device that was previously paired (ex. TAG) will be cleared. You will have to pair the devices all over again. It must therefore only be used in case of need, before programming the system or learning the turn indicators flashes.

To reset the system proceed as follows:

- Disconnect the alarm power supply.
- Short-circuit the RED and BLACK wires of the 2-pin LED connector.
- Power the system; 4 acoustic signals and 4 flashes of the turn indicators will confirm the operation.
- Remove the previously created short-circuit; the status LED will light up steady.
- Turn ignition key “ON”; reset is confirmed by an acoustic signal and the wailing of the siren for approx. 3 sec.
- Turn ignition key “OFF”; the status LED will turn OFF. There are no acoustic signals.

14.0 - TECHNICAL SPECIFICATIONS

Power supply	12 Vdc
Current absorption @ 12Vdc with system armed and LED flashing	15mA
Working range temperature	-30°C to +70°C
Turn indicators relay contact capacity	8A @ 20°C
Engine immobilizer relay contact capacity	8A @ 20°C
Alarm cycle duration	30 sec.
Maximum positive current output with system armed (+A)	700mA
Maximum load of siren output	1A

15.0 - WASTE ELECTRICAL AND ELECTRONIC EQUIPMENT (WEEE) DIRECTIVE

The present device does not fall within the scope of Directive 2002/96/EC on Waste Electrical and Electronic Equipment (WEEE) as specified in art. 2.1 of L.D. no. 151 of 25/07/2005.